



MARCO ANTONIO MARTINS FERREIRA

urban designer ~ born 22 July 1980 in Caracas Venezuela ~ holds EU passport, category B driving licence, licentiate in architecture and urbanism ~ lives in Sweden and can be reached at www.minimalisticapproach.org, +46764064771.

PROFILE

Marco Antonio is an urban designer and the founder of [ma], a design organisation with a minimalistic approach to the creation and development of the human made world. with over twenty years of international experience and a background in complex schemes, Marco Antonio's career spans from concept to design development in Fabrication, Architecture, Landscape and Planning projects. opportunely, he has succeeded to exert the minimalistic approach manifesto to produce and implement significant design solutions worldwide.

EXPERIENCE

2000-current worldwide ~ [ma] ~ founder and director: promotion of creation principals ~ direction on design strategies and methodologies in an international organisation ~ research on lasting and timeless solutions ~ practice of design evaluations, visions, concepts and development ~ provision of planning and design consultancy in urban development.

2018-2020 China Shanghai ~ Hua Hui Design (HHD) ~ design director: consultancy and participation on urban design projects in Tianjin and Shanghai offices (7 offices in 5 cities with 100 employees in Planning) ~ practice of A-grade Planning with urban design evaluations, concepts, developments and guidelines ~ promotion of sustainable and versatile structures ~ presentation of four-dimensional spaces ~ direction on community and business centres ~ town regeneration ~ design of park district, residential neighbourhoods and hill-town ~ guidance and tutorship on design methodologies and production ~ production of hand drawings.

2016-2017 China Wuhan ~ United Design Group (UDG) ~ design director: consultancy on urban design concepts ~ management of independent studio for urban design at USA/China consultancy firm ~ leadership of multidisciplinary team of 6 (office of 80) ~ marketing of company's goals and studio's philosophy (2,500 employees in China, branched in 11 cities) ~ design of mixed-use neighbourhoods, city expansion and central culture district ~ presentation and promotion of sustainable solutions ~ production of hand drawings.

2016-2017 China Wuhan ~ Wuhan University (WHU) ~ teacher and guest lecturer: consultancy to a top 10 national research university ~ preparation of courses for School of Urban Design (1,300 students) ~ instruction in renovation and renewal, urban frameworks and housing complexes ~ presentations on urban design and design concepts ~ review of final assignments ~ consultation with students.

2017 China Wuhan ~ Huazhong University of Science and Technology (HUST) ~ guest critic: contribution to the Faculty of Architecture and Urban Planning at a top 10 research university ~ review and evaluation of students' final presentation.

2015-2016 Sweden Stockholm ~ AIX Architects ~ project designer: practice of architecture, landscape and urban design evaluations, concepts and guidelines for one of the biggest architectural practice in Sweden ~ report to commerce, housing, and city development office sectors ~ design of residential neighbourhood, residential complexes, residential buildings, mixed-use neighbourhood, mixed-use city block, hotels, office complex and city districts ~ presentation of sustainable and resilient structures ~ production of CIM models, hand drawings and rendering images ~ introduction of design process, standards and policies ~ guidance and tutorship on design methodologies.

2015 Sweden Stockholm ~ KTH [Royal Institute of Technology] ~ guest lecturer: lectureship at the School of Architecture at country's largest technical research and learning institution ~ presentation about cities and design in the International Contemporary Architecture course.

2014-2015 China Shanghai and Tianjin ~ Hua Hui Design (HHD) ~ head designer: report to principal of environmental planning and design consultant company (HQ Tianjin) ~ practice of A-grade Planning with urban design concepts, developments and guidelines ~ consultancy and participation on all urban planning and landscape projects in both offices ~ leadership of urban planning teams ~ coordination and management of team of 3 ~ design of city expansion, civic district and central business district ~ presentation of transit-oriented developments ~ promotion of ecological strategies ~ production of models and hand drawings.

2013-2014 China Shanghai ~ United Design Group (UDG) ~ design director: report to department director at HQ Shanghai (staff of 800) ~ guidance on all projects in the department of urban planning & landscape (staff of 60) ~ practice of urban planning and design concepts ~ design of residential neighbourhood, residential district and central business district ~ presentation of compelling competitions ~ production of mass models and hand drawings.

2012-2013 Sweden Stockholm ~ AIX Architects ~ project designer: practice of urban design concepts and architecture design, developments and implementations ~ report to historical, education and commerce office sectors (office of 100) ~ coordination of ideas and solutions ~ contribution with values and strategies ~ design of music campus, hotel and office complex ~ delivery of harmonious and balanced structures ~ production of BIM models and hand sketches ~ tutorship on parametric modelling.

2010 Finland Helsinki ~ Eriksson Architects, Tengbom Group ~ independent designer: contribution to the urban planning and design departments of 6 and 8 respectively (office of 30) ~ report to office's principal of a top innovative architectural firm in the world (600 employees) ~ practice of architecture and urban design concepts ~ delivery of innovative studies ~ design of housing and office complexes and residential neighbourhoods.

2008-2009 Norway Skien ~ Context ~ project designer: practice of urban planning concepts and developments at architectural practice and environmental consultancy (10 employees) ~ promotion and introduction of urban ideas and strategies ~ planning and design of industrial parks in the world heritage town of Rjukan ~ production of models and drawings.

2008 Portugal Porto ~ GEG [Office of Structures and Geotechnics] ~ consultant urban designer: working in Portugal, Libya and Angola for an international engineering design and consulting company (HQ in Porto with 30 employees) ~ representation of the public interests within a team of architects, civil engineers and geo-technicians ~ practice of urban planning and landscape design evaluations, concepts and developments ~ introduction and coordination of ideas and strategies ~ coordination of team of 4 ~ assistance on the phasing process ~ supervision and delivery of documents ~ design of light-rail systems, road network and campus ~ delivery of sustainable infrastructures ~ production of hand sketches and presentations.

2008 United Kingdom London ~ Pitman Tozer Architects ~ consultant architect: assistance in office chores (architecture studio of 5) ~ practice of architecture design development ~ participation with ideas for residential and educational building~ production of drawings.

2006-2008 Sweden Stockholm ~ BAU [Office for Architecture and Urbanism] ~ project architect & CAD manager: leadership and management of office's CAD standards, resources, and policies (spearheads in environment development and BIM design) ~ practice of architecture and urban design concepts and developments and implementations (40 employees) ~ coordination of project teams (5-8 architects) and site tasks ~ report to project manager ~ design of arena district and mixed-use complex ~ contribution with ideas ~ delivery of inspiring frameworks ~ production and supervision of BIM models and drawings.

2007 Sweden Stockholm ~ Blue Architecture Landscape ~ consultant architect: practice of architecture and urban design concepts (office of 5) ~ support on drawing production ~ participation on ideas and strategies ~ design of housing complexes ~ delivery of modular structures ~ production of models and hand sketches.

2006 Portugal Porto ~ Nuno Guilherme Pacheco (NGP) ~ assistant architect: report to leading architect (architecture office of 10) ~ practice of architecture design developments and implementations ~ participation with ideas for residential buildings and industrial park ~ assistance on project process and documents ~ production of drawings.

1999-2005 Portugal Porto ~ FAUP [University of Porto, Faculty of Architecture] ~ licentiate degree, architecture & urbanism: 6 years programme (master's degree equivalency) in one of the most competitive universities in Europe and the most international university in Portugal.

2003-2004 Sweden Stockholm ~ KTH [Royal Institute of Technology], School of Architecture ~ master's level: EU student exchange programme, Erasmus ~ credits in art, history and urban design.

SKILLS

management: projects, schedules, software.

coordination: ideas, teams, office and site tasks.

documentation: assessments, surveys, briefs, conceptual presentations, technical drawings.

computing: CAD, BIM, GIS, graphics rendering, animation, image editing, illustration, graphic layout, spreadsheeting.

teaching: mathematics, geometry, composition, drawing, design, project planning.

construction: carpentry, electricity, piping systems, building structure.

artistry: drawing, painting, photography, music (composition), poetry, gastronomy.

language: Portuguese (mother tongue), English (fluent), Spanish (independent), Swedish (basic).

REFERRALS

Leon Huang: president and founder of Hua Hui Design, +8618622182250.

Kevin Guo: department director at United Design Group, +8613917227000.

Sven Ahlenius: partner of AIX Architects, +46706906166.

Peter Walker: partner and CEO of Byrån för Arkitektur och Urbanism, +46706354236.

Nuno Pacheco: owner of NGP Arquitectura, +351225509190.

Nuno Lacerda: owner of CNLL Architects, +351227347599.

PROJECTS

list of selected projects is attached.

worldwide ~ BRICK: modular urban development

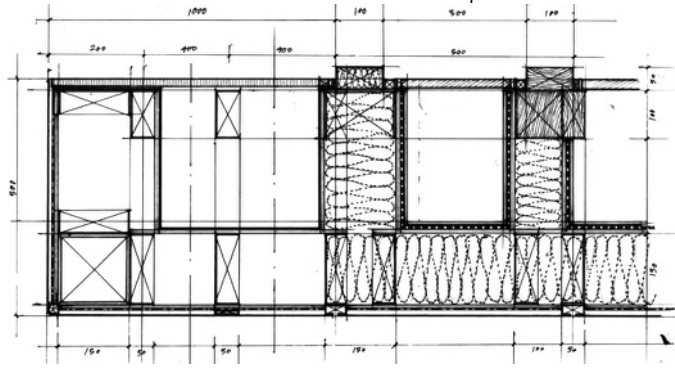

worldwide ~ the Movables: furniture

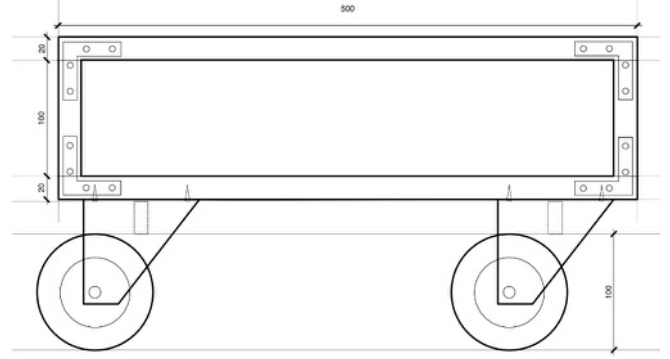
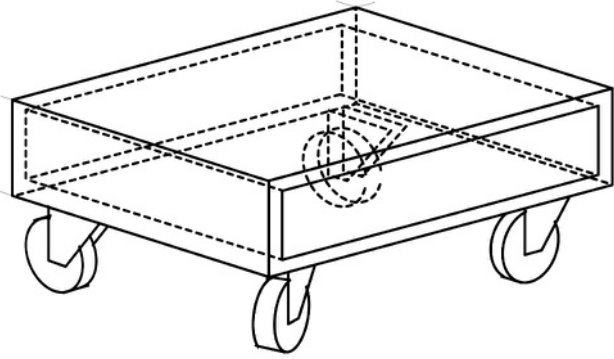

Portugal Santo Tirso ~ the Corner of the Rua da Ponte Velha & the Rua das Tílias: villa

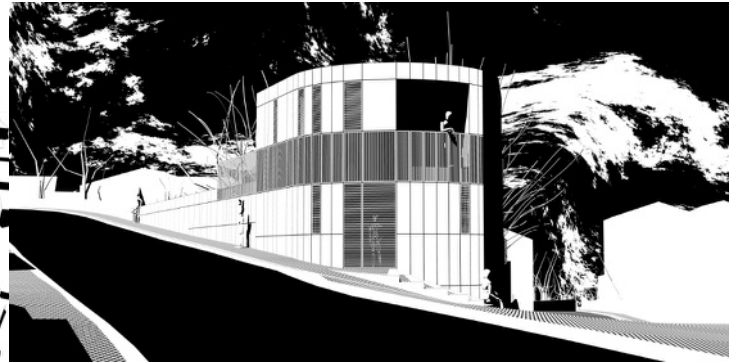

China Chengdu ~ Hills Grove: international community

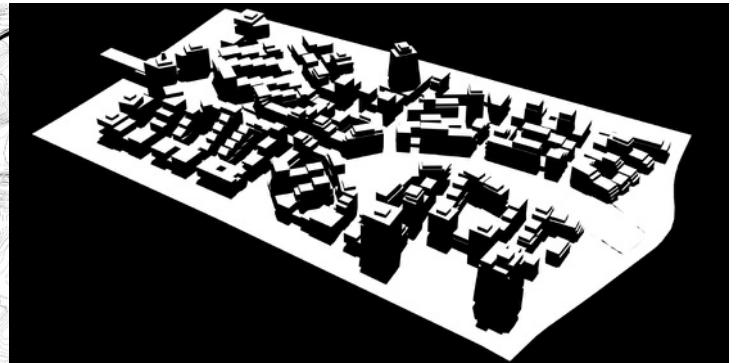

China Linhai ~ Touden Port-Town: residential district

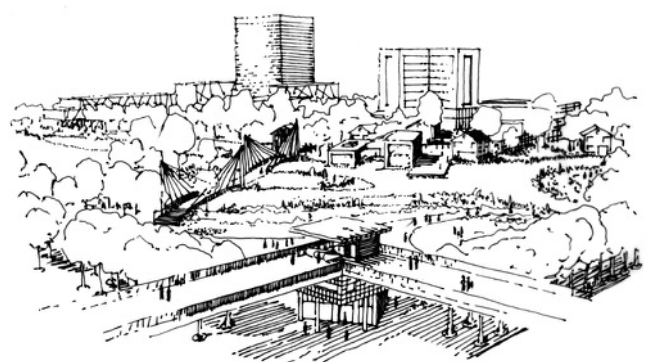

China Hefei ~ City & Park: central park district, renewal of airport grounds

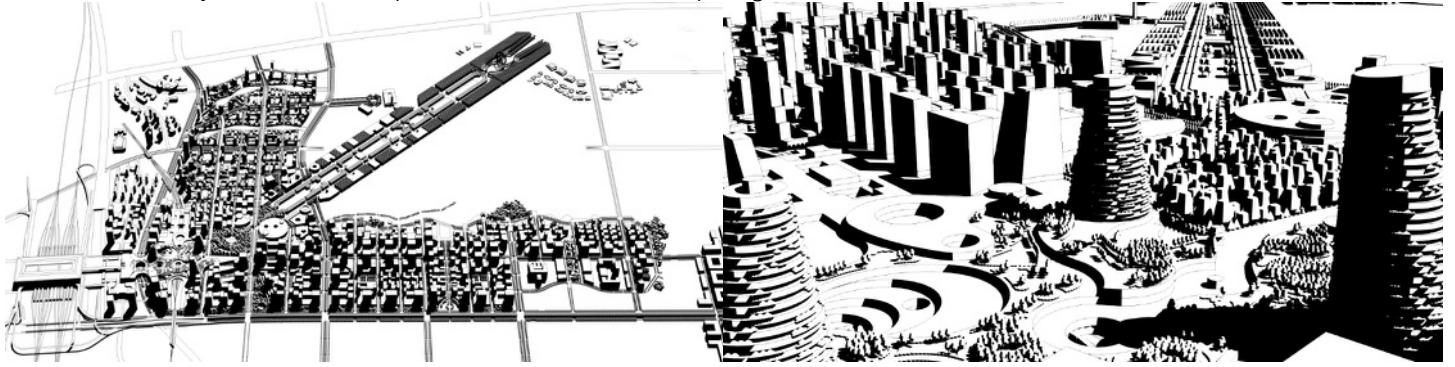

worldwide ~ Tee: shirt

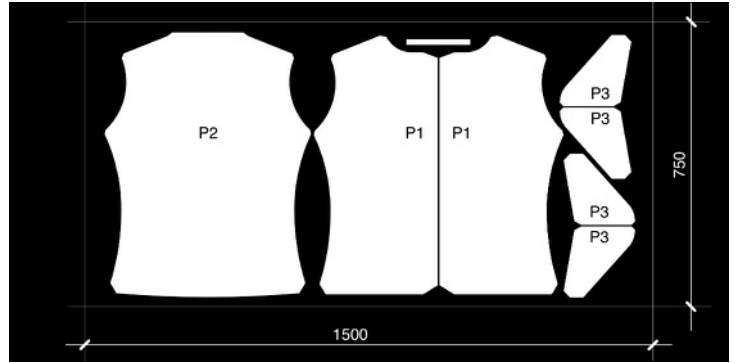
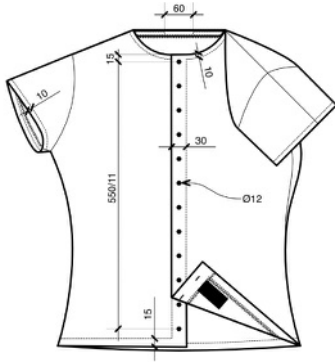

China Wuhan ~ Versatile Centre: mixed-use neighbourhood, renewal of food market

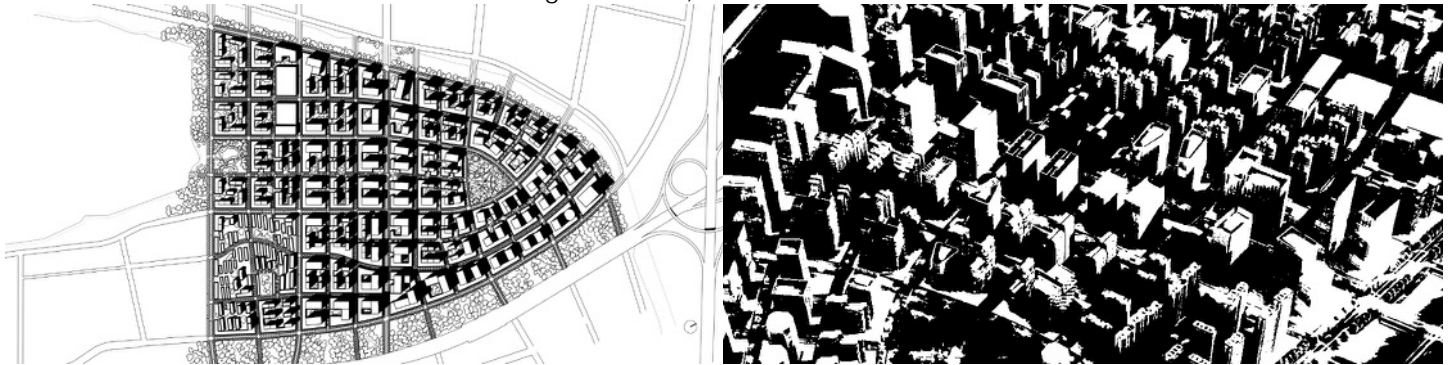

China Jinkou ~ Nature in Place: city expansion



China Danyang ~ GOD: central culture district, regeneration of temple and renewal of agricultural grounds



Portugal Sintra ~ Sea Home: villa

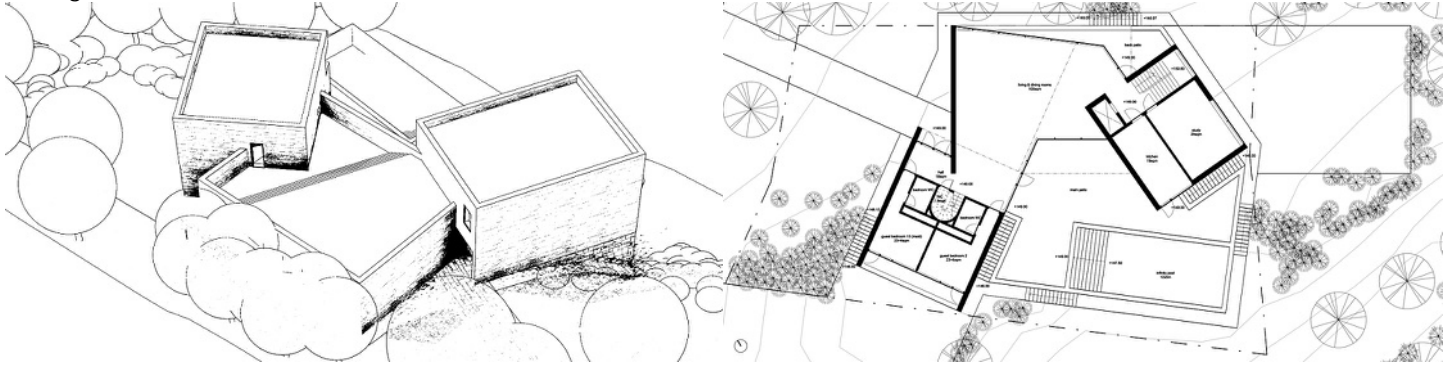

Sweden Åre ~ Tottparken: residential complex

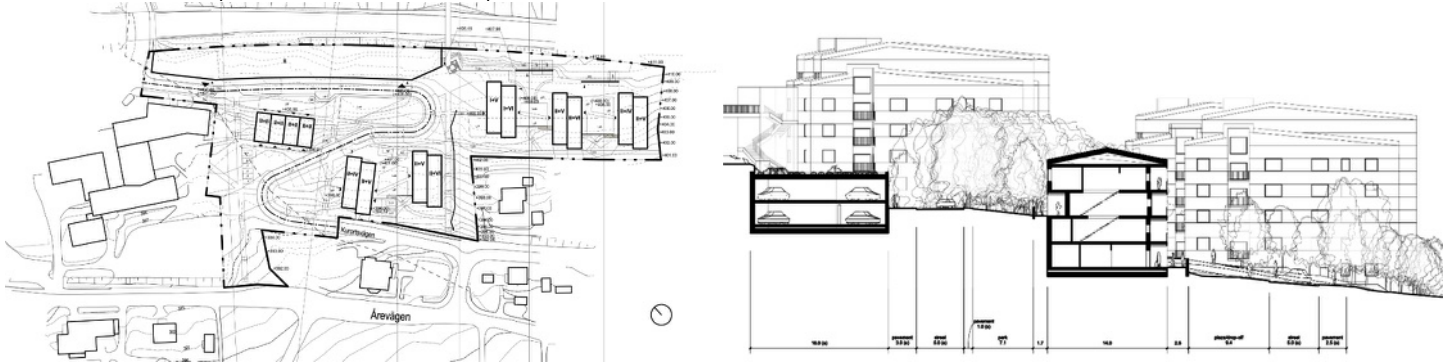

Sweden Stockholm ~ Lydmar Updated: add-on, regeneration of luxury hotel

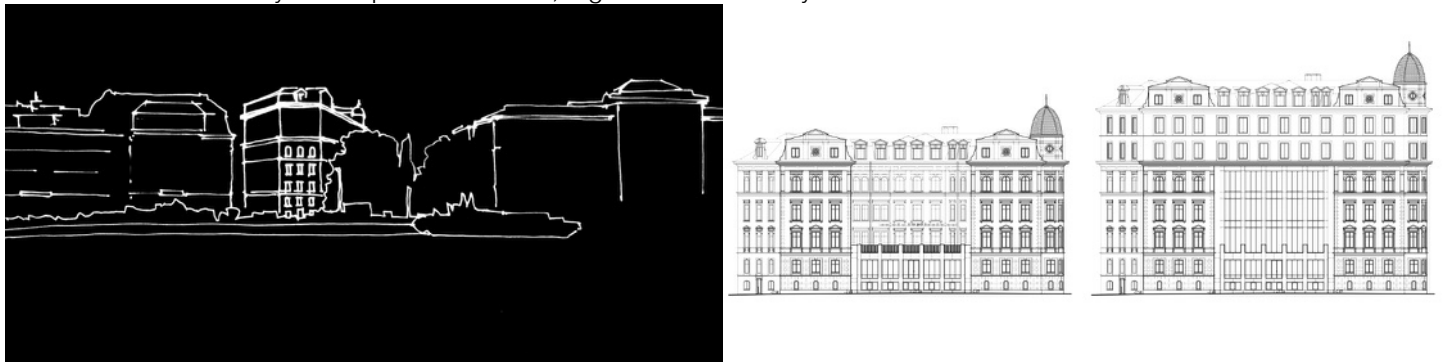

Sweden Södertälje ~ Share: housing

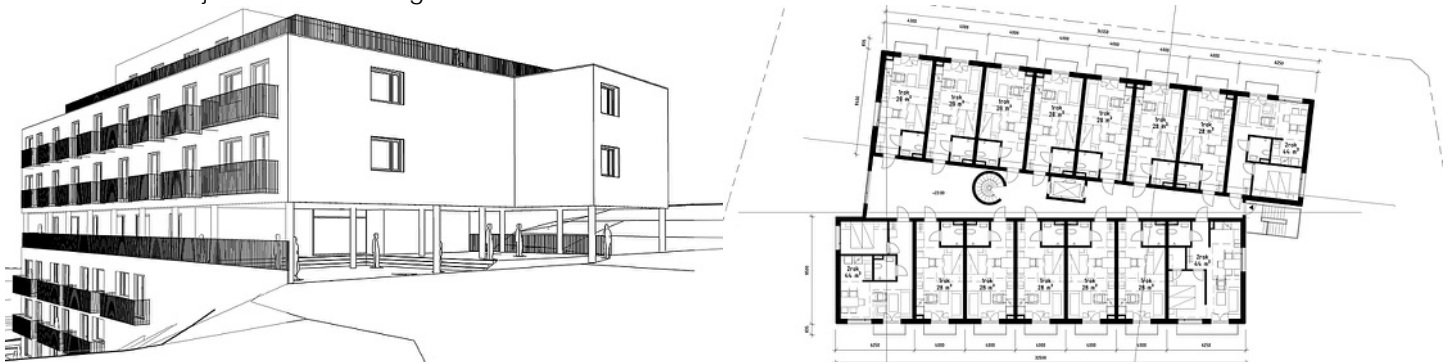

Sweden Stockholm ~ Quay Squares: mixed-use neighbourhood, renewal of harbour

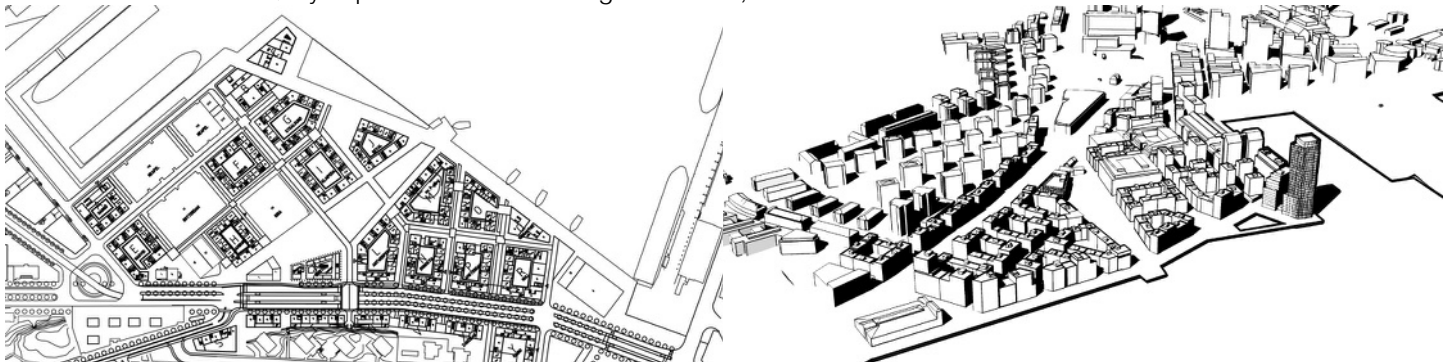

China Haikou ~ POD: central business district, renewal of airport grounds

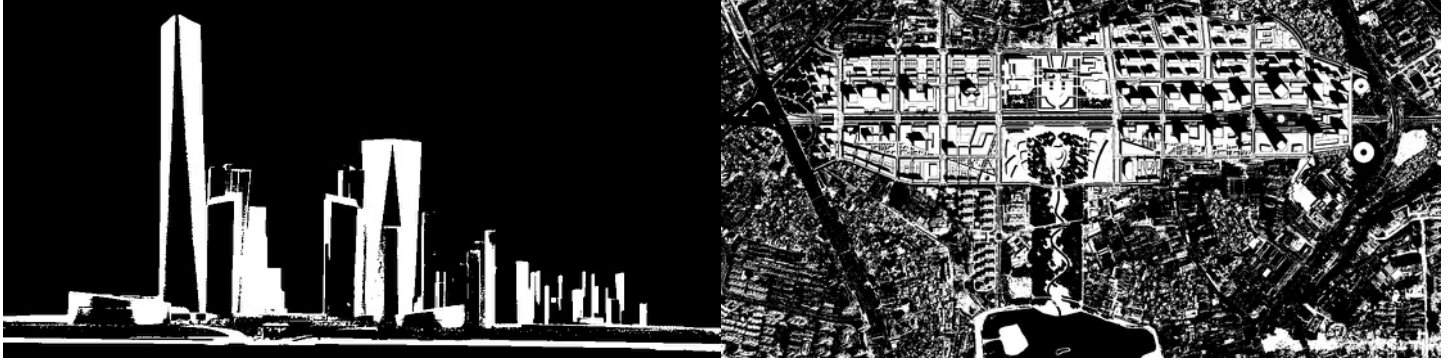

China Xitang ~ Cross of Socioecology: residential district

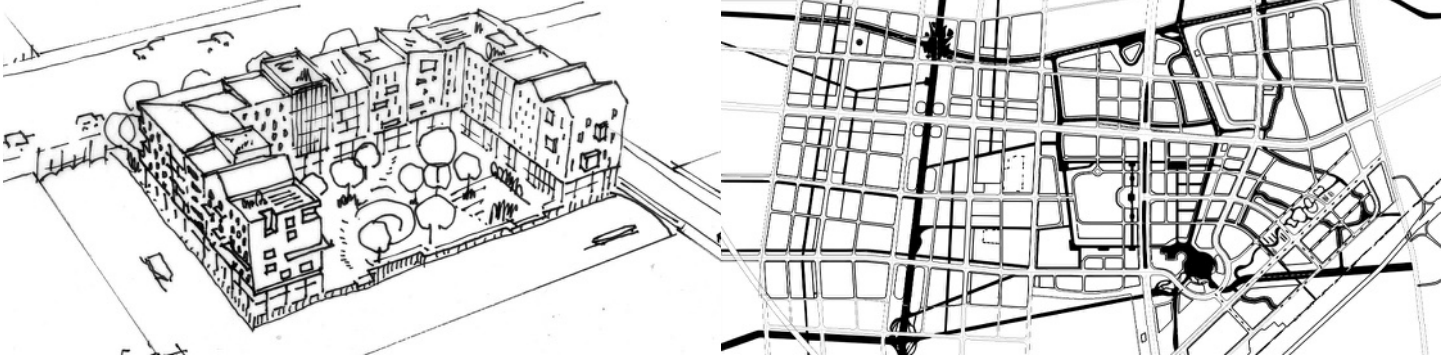

China Yibin ~ Yibin's Axis: central business district, renewal of riverfront

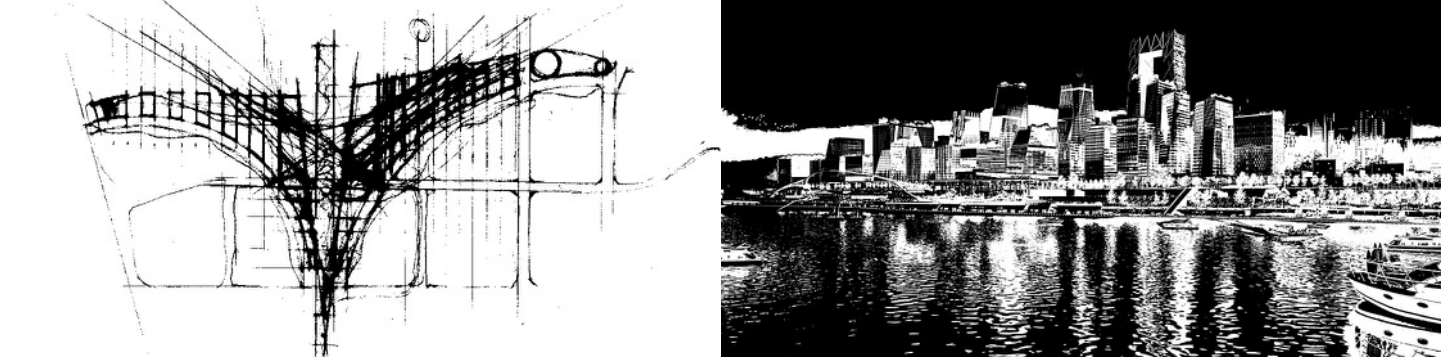

Sweden Stockholm ~ KMH: campus, renewal of city block

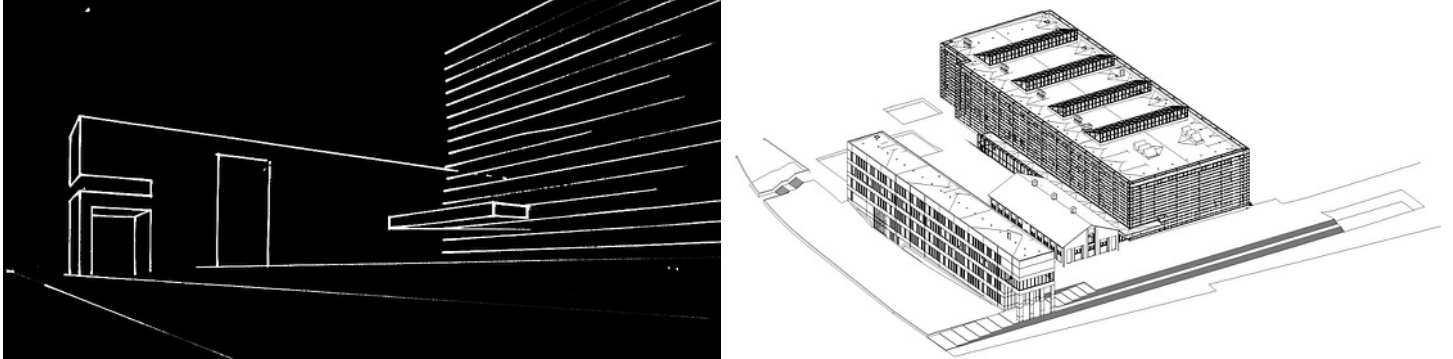

Sweden Stockholm ~ Enter the Park: regeneration of city park and campus

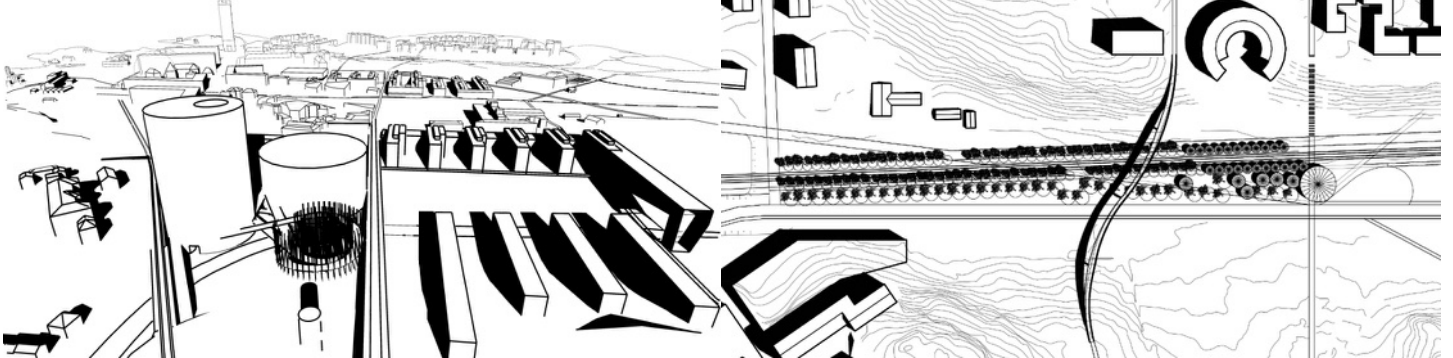

Finland Lohja ~ the Lighthouses: housing complex

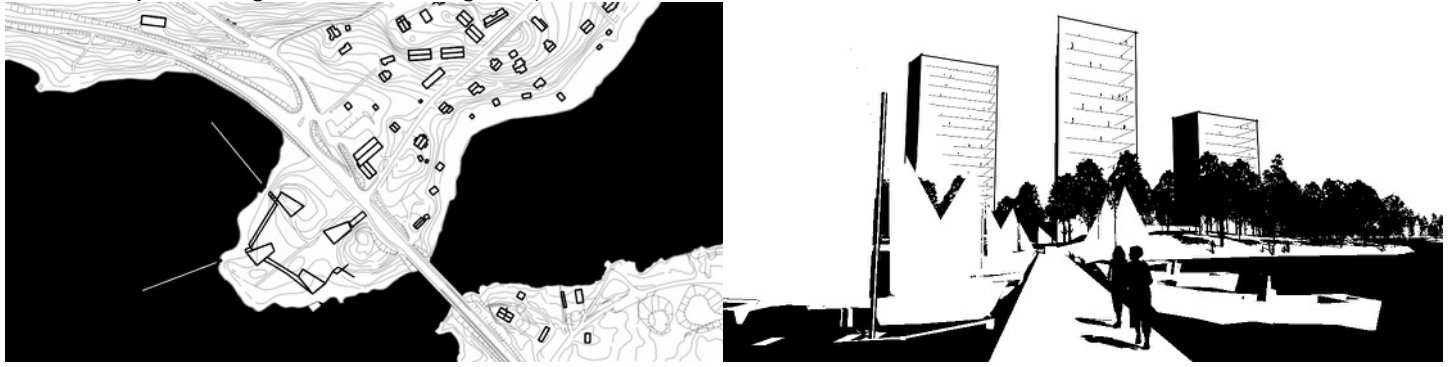

Norway Rjukan ~ Humanisation: regeneration of industrial parks



Sweden Solna ~ New Solna's District: arena district, renewal of industrial area



Portugal Felgueiras ~ the Granary Estate: villa

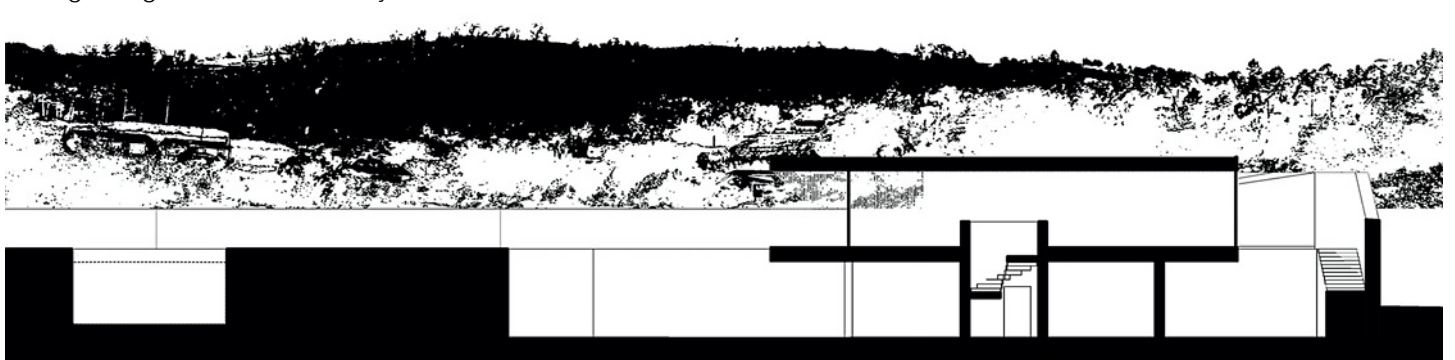

Portugal Porto ~ CEEA: business park, renewal of industrial area

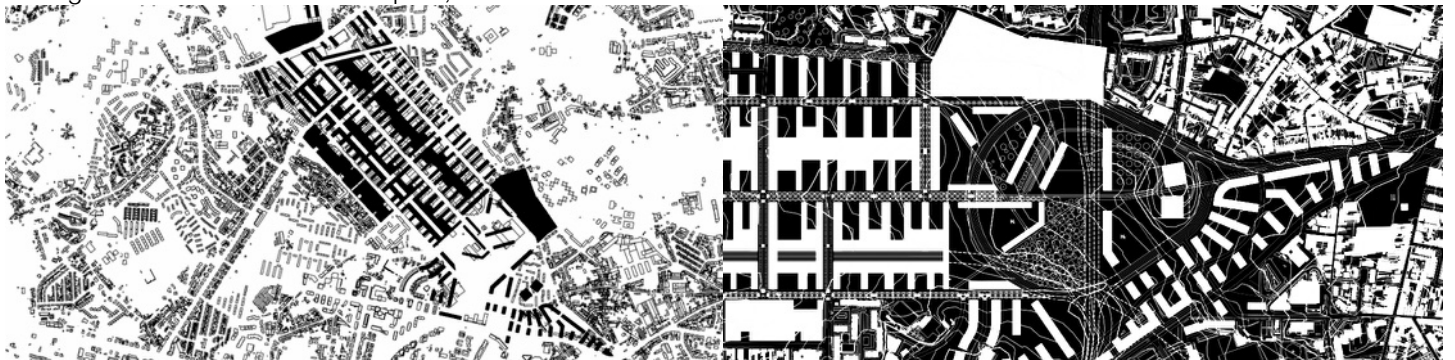

worldwide ~ Lotus: bag

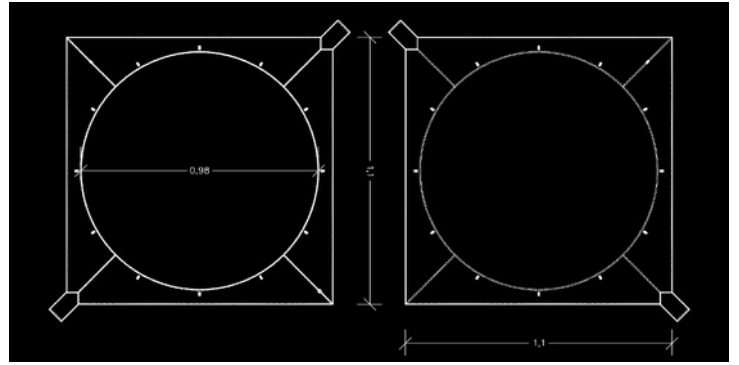
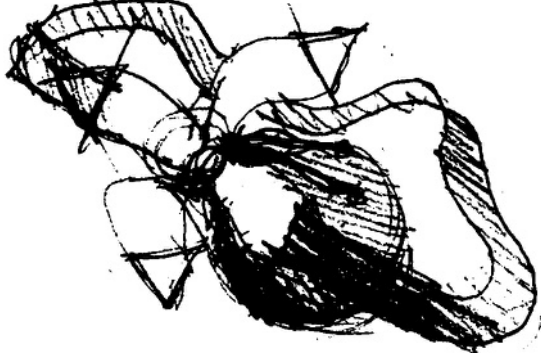

Portugal Porto ~ IFT: archive and exhibition hall

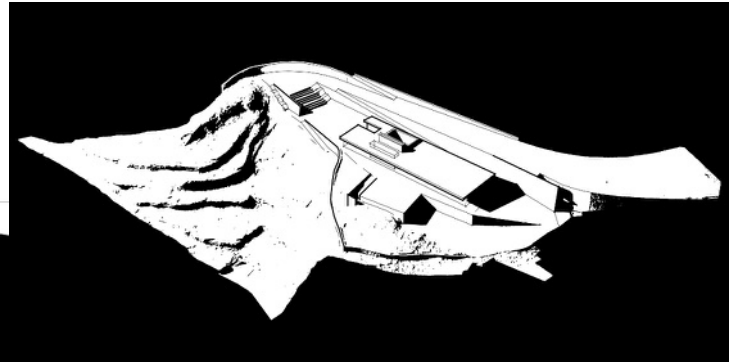
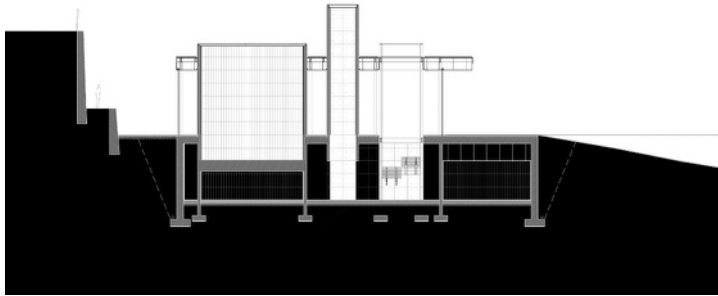

Portugal Porto ~ Versatility In'habiting: housing and retail complex

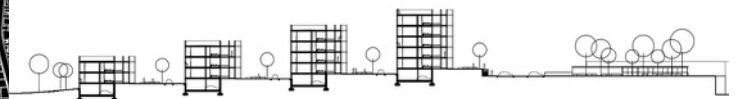

Portugal Porto ~ Parque das Camélias: mixed-use complex, renewal of city block

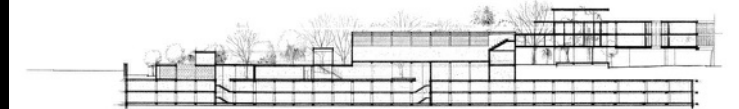
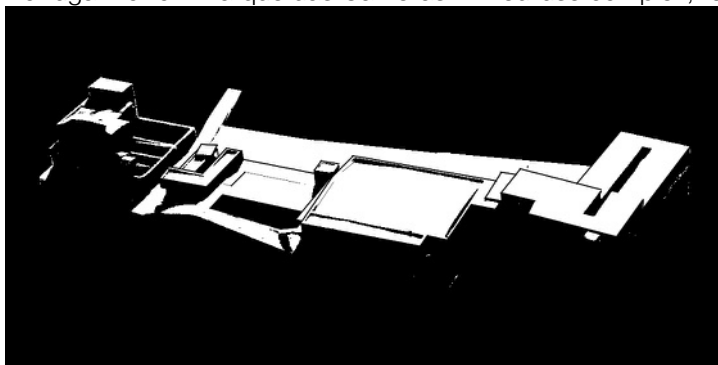

Portugal Porto ~ o Polvo: student residence

